

TRUERGB+W
ADAPT



tivoli®



Project: _____ TYPE: _____

- Now available with our ADAPT globe family
- Tivoli's proprietary algorithm controls RGB+W (5000K) LEDs for superior color saturation and TRUE white performance with only 3 channels of DMX other than a standard 4 channel system
- True RGB +W Technology delivers more than 16 million combinations of pure and precise color tones
- Audio enhanced with MADRIX 5 software
- Individually control each globe with DMX512 protocol for a unique and personal environment
- Each globe is auto-addressed for fast set-up and connection
- Tivoli's proprietary PCB design delivers a high level performance and easy replacement
- Two mounting options for suspended and a twist-off cap for surface applications
- 24V DC Low voltage system for long runs
- Pre-molded twist connect male and female power leads for multiple runs
- IP67
- cULus listed
- 3 Year warranty

Dimensions





Strand Order Guide

Note: For suspension application, a catenary cable is required for proper installation. Please contact Tivoli for recommendations on unique mounting applications.

Strand Order Guide - 12" OC Max electrical run length (80 total globes each circuit): **80'**

PRODUCT CODE	WIRE	SPACING	LED TYPE	GLOBE	LENGTH	LIGHT SHADE	VOLTAGE
LSTA LSTA = ADAPT True RGB+W	BK = Black WH = *White	12 12 = 12" OC	RGBW = Red Green Blue +White 5000K	ANA = Ana VIC = *Victoria GAB = Gaby LAU = *Laura GIN = Gina ANG = Angela BRE = Brenda KAT = Katie SUS = *Susan TON = *Toni LUC = *Lucia CG = *Mix Globes	10 = 10' 40 = 40' 80 = 80'	Y = Yes N = No	24 24 = 24V DC

*Consult factory for MOQ and lead-time

Strand Order Guide - 24" OC Max electrical run length (80 total globes each circuit): **160'**

PRODUCT CODE	WIRE	SPACING	LED TYPE	GLOBE	LENGTH	LIGHT SHADE	VOLTAGE
LSTA LSTA = ADAPT True RGB+W	BK = Black WH = *White	24 24 = 24" OC	RGBW = Red Green Blue +White 5000K	ANA = Ana VIC = *Victoria GAB = Gaby LAU = *Laura GIN = Gina ANG = Angela BRE = Brenda KAT = Katie SUS = *Susan TON = *Toni LUC = *Lucia CG = *Mix Globes	10 = 10' 80 = 80' 160 = 160'	Y = Yes N = No	24 24 = 24V DC

*Consult factory for MOQ and lead-time



Specifications

Output	
Kelvin Temperature	Red / Green / Blue / White (5000K)
Pixels	1 pixel/globe
Lumens (lm/globe)	55 (all color fully on)
Electrical	
Input Voltage	24V DC
Power Consumption (W/globe)	1
Maximum Run (based on O.C. spacing)	80' @ 12" O.C., 160' @ 24" O.C. (Total 80 globes per circuit)
Control	
Control System	DMX 512
Address Setting	Auto Addressing
Physical	
Socket Housing	PVC
Globe	Glass (Shatter resistance assist with silicone coating - Glass may still break under certain conditions)
Mounting	Surface Mount, Suspended
Operating Temperature	-20°C to 50°C (-4°F to 122°F)
Storage Temperature	-40°C to 80°C (-40°F to 176°F)
Certification and Testing	
Certification	cULus
Environment	Wet Location
IP Rating	IP67
Warranty	3 Years

Weights OC Spacing (G125 Globe)	12"	24"
lb/ft	0.48	0.42
lb/ft with catenary cable	0.50	0.44
Weights OC Spacing (ST19 Globe)	12"	24"
lb/ft	0.49	0.41
lb/ft with catenary cable	0.51	0.43

Photometrics - based on 5" Lucia Globe

Maximum Candela = 5.6
 Located At Horizontal Angle = 0
 Vertical Angle = 0
 #1 Vertical Plane Through Horizontal Angles (0-180) (Through Max. Cd.)
 #2 Vertical Cone Through Vertical Angle (0) (Through Max. Cd.)

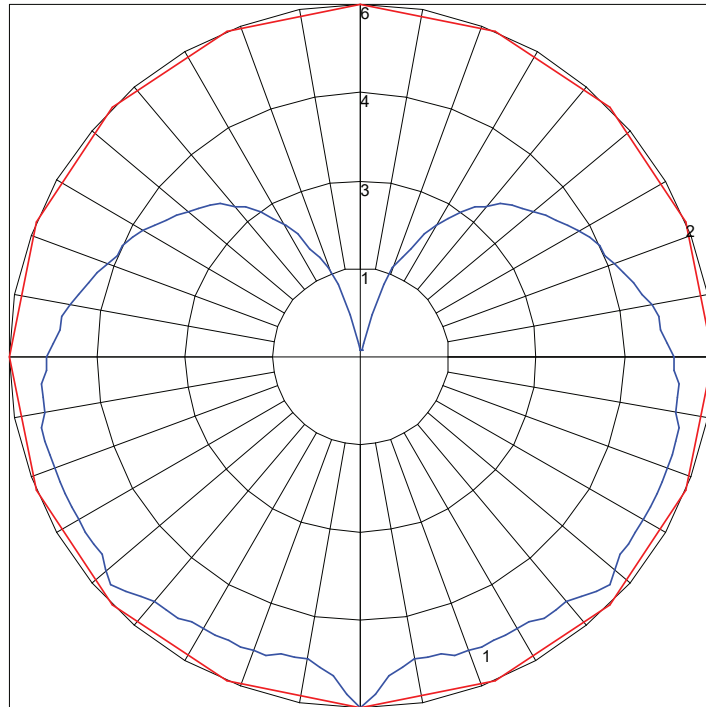

TM-30-15

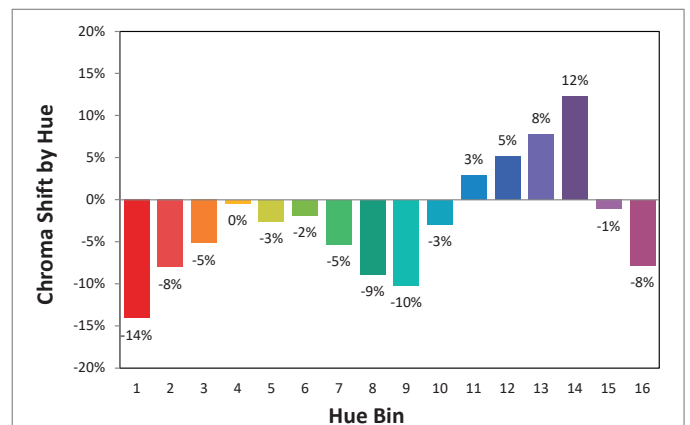
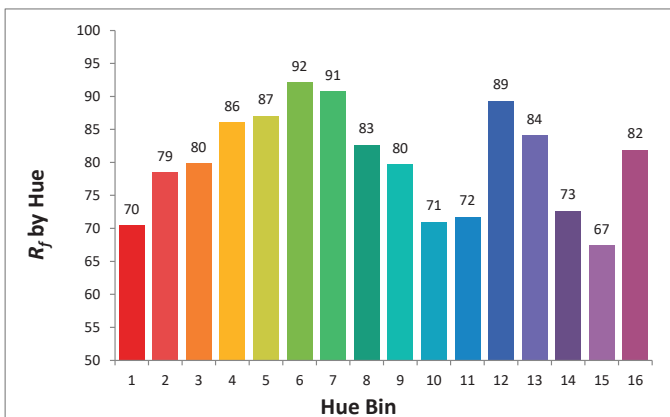

TM-30-15

R_f	R_g	CCT (K)	D_{uv}	u'	v'
81	94	6887	0.0030	0.1961	0.4642

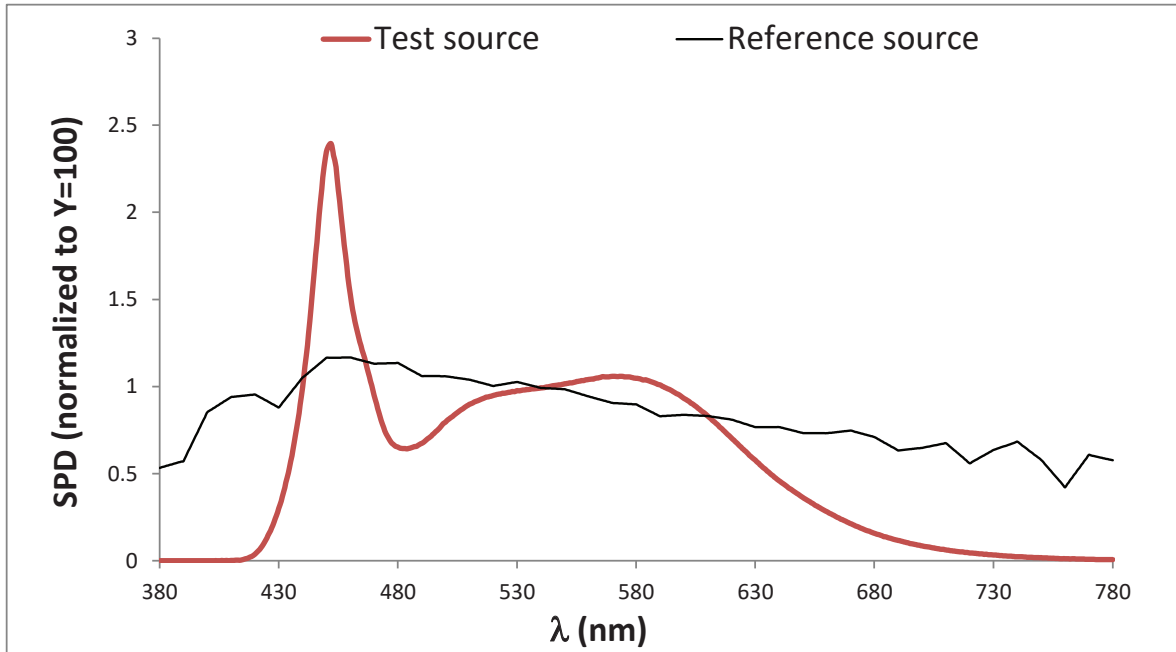

Color Vector Graphic

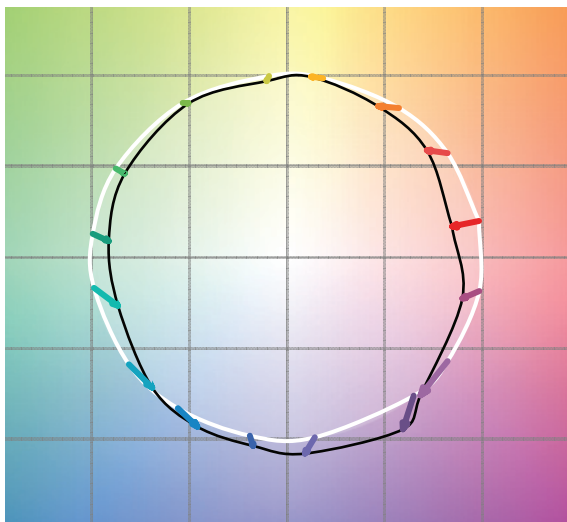

Hue Bin	R_f	Graphic Shifts (%)	
		Chroma	Hue
1	70	-14%	0%
2	79	-8%	7%
3	80	-5%	9%
4	86	0%	6%
5	87	-3%	2%
6	92	-2%	-2%
7	91	-5%	0%
8	83	-9%	2%
9	80	-10%	12%
10	71	-3%	17%
11	72	3%	14%
12	89	5%	3%
13	84	8%	-7%
14	73	12%	-15%
15	67	-1%	-23%
16	82	-8%	-6%

Wiring Diagram

Online Operation

MADRIX (Live)

This is a live control performance setup. Widely used for concerts or performance-based manipulation. Use of a live network is necessary for communication between MADRIX software and Litesphere True RGB+W.

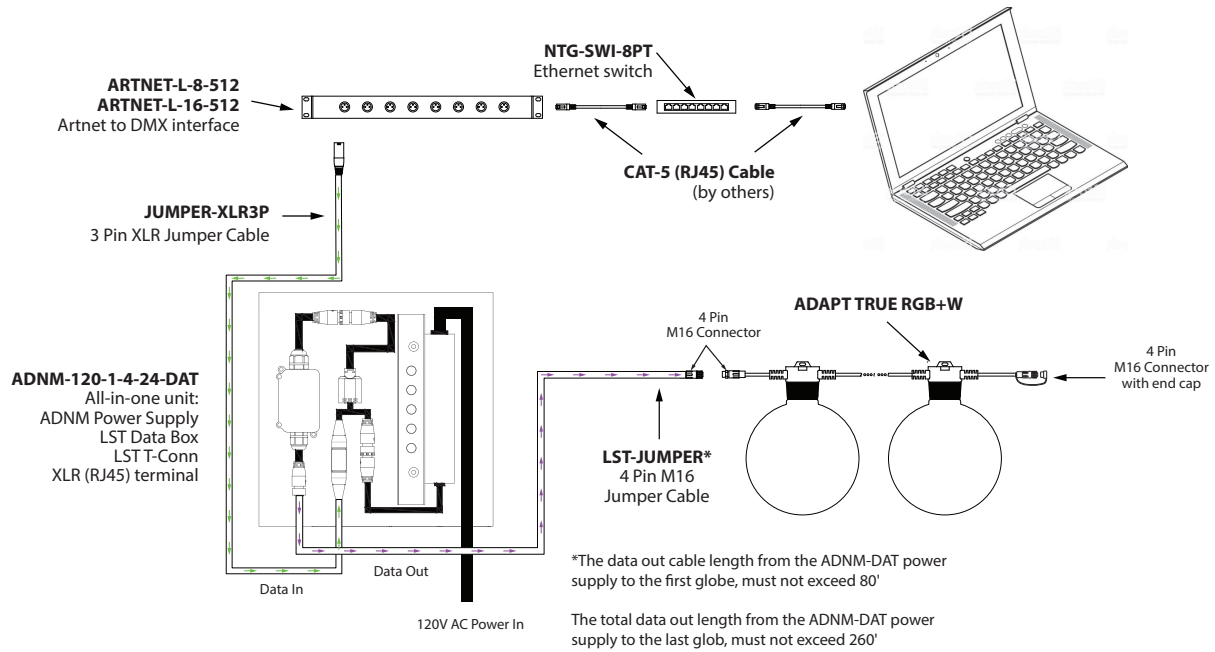

Off-line Operation

TivoCUE (Preset)

Programmed via CUE software and recorded to a Micro SD card for data transfer into TivoCUE control. This is a stand-alone feature with no need for network support by software (CUE) once recorded and transferred to in-wall DMX control hardware. Please refer to TivoCue10 User Manual for additional information.

Note: TivoCue10 controls a maximum of 1 universes with 80 pixels (globes) total. Consult factory for 160 pixels (globes) maximum option.

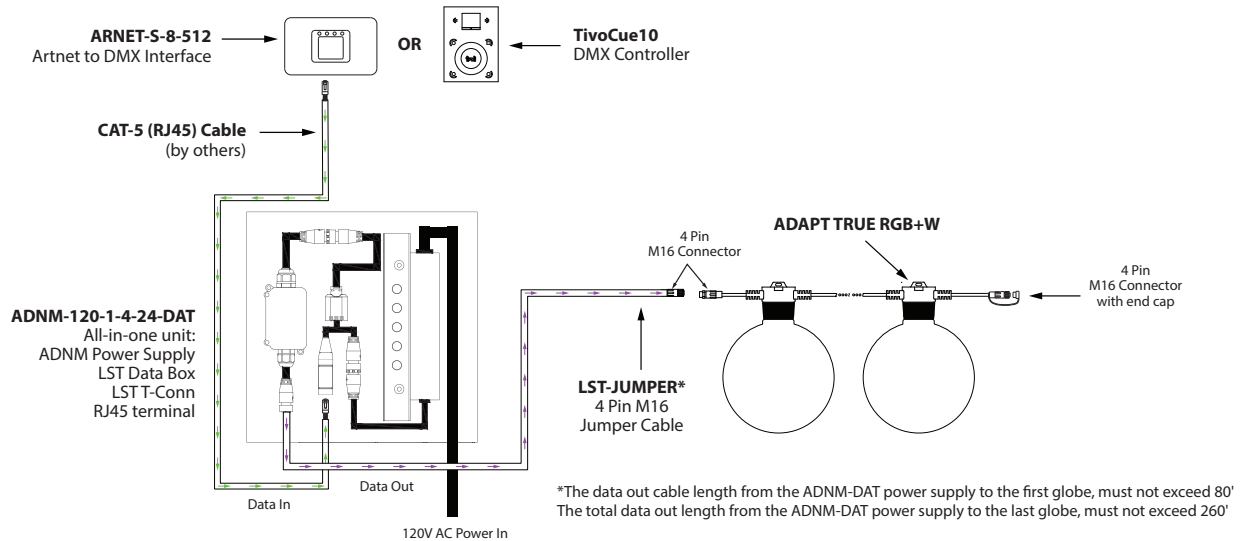

Wiring Single Run with single circuit 96W

WARNING! Risk of Product Failure

The data & power out cable length from the ADN-M-DAT power supply to the first globe, must not exceed 80'

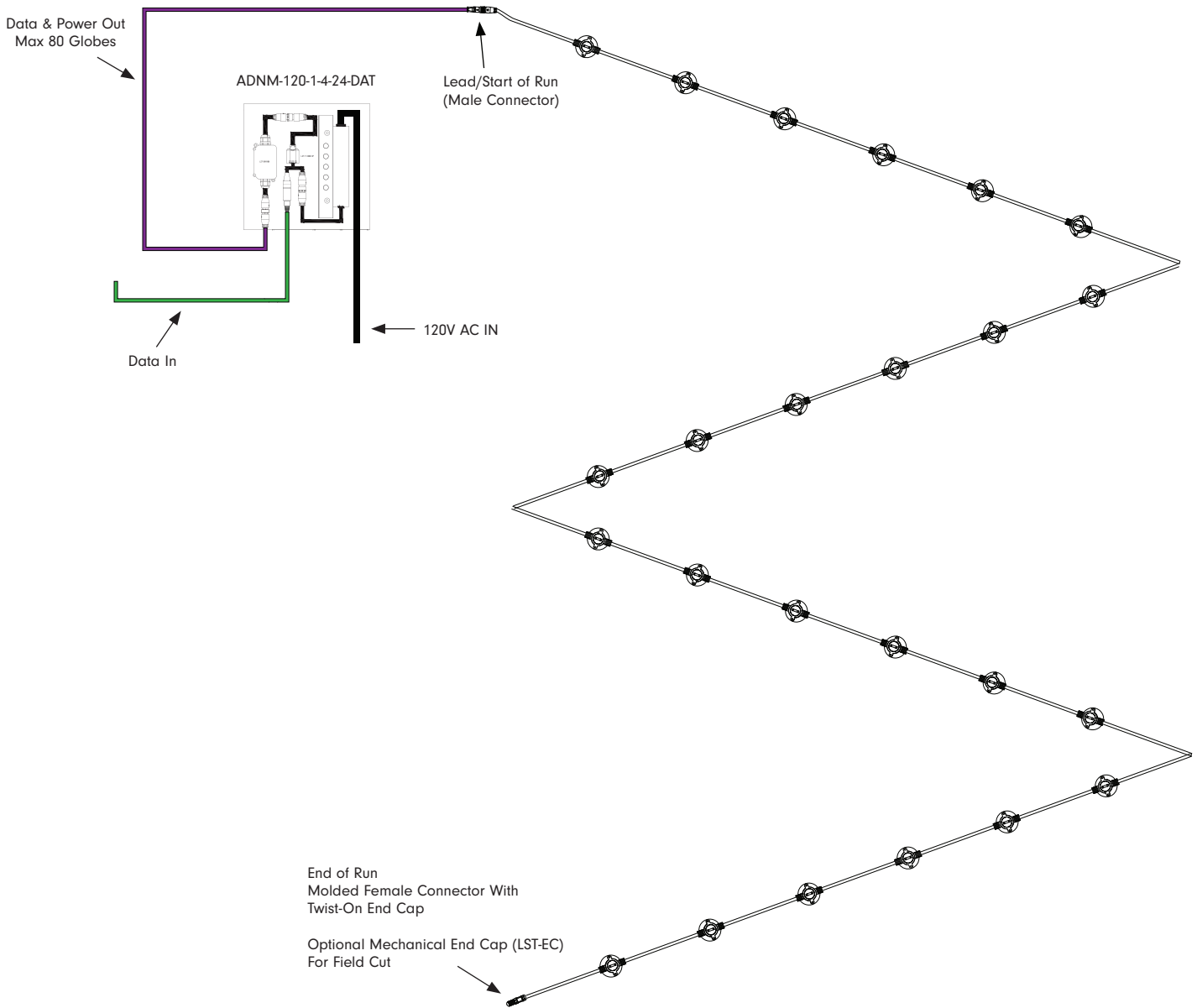

⚠ Warnings: Risk of injury or fire.

Do not cover any luminaire as the covering may cause it to overheat.

Do not install this lighting system where the exposed bare contacts can be shorted or contact any conductive material to reduce the risk of fire and burns.

Do not install any luminaire closer than 6 inches (15.25cm) from any curtain, or similar combustible material.

Do not use any luminaire if damaged; such as, broken globe, loose connections, or frayed wire insulation. Inspect periodically.

Do not submerge any luminaire in liquid. Use waterproof connectors for all outdoor applications.

Do not secure any luminaire with staples, nails or like means that might damage the wire insulation. Secure it by using screws through the base.

Do not run any luminaire at an operating temperature exceeding -20°C to 50°C (-4°F to 122°F)

Wiring Multiple Runs with multi circuit 96W

WARNING! Risk of Product Failure

The data & power out cable length from the ADNM-DAT power supply to the first globe, must not exceed 80'

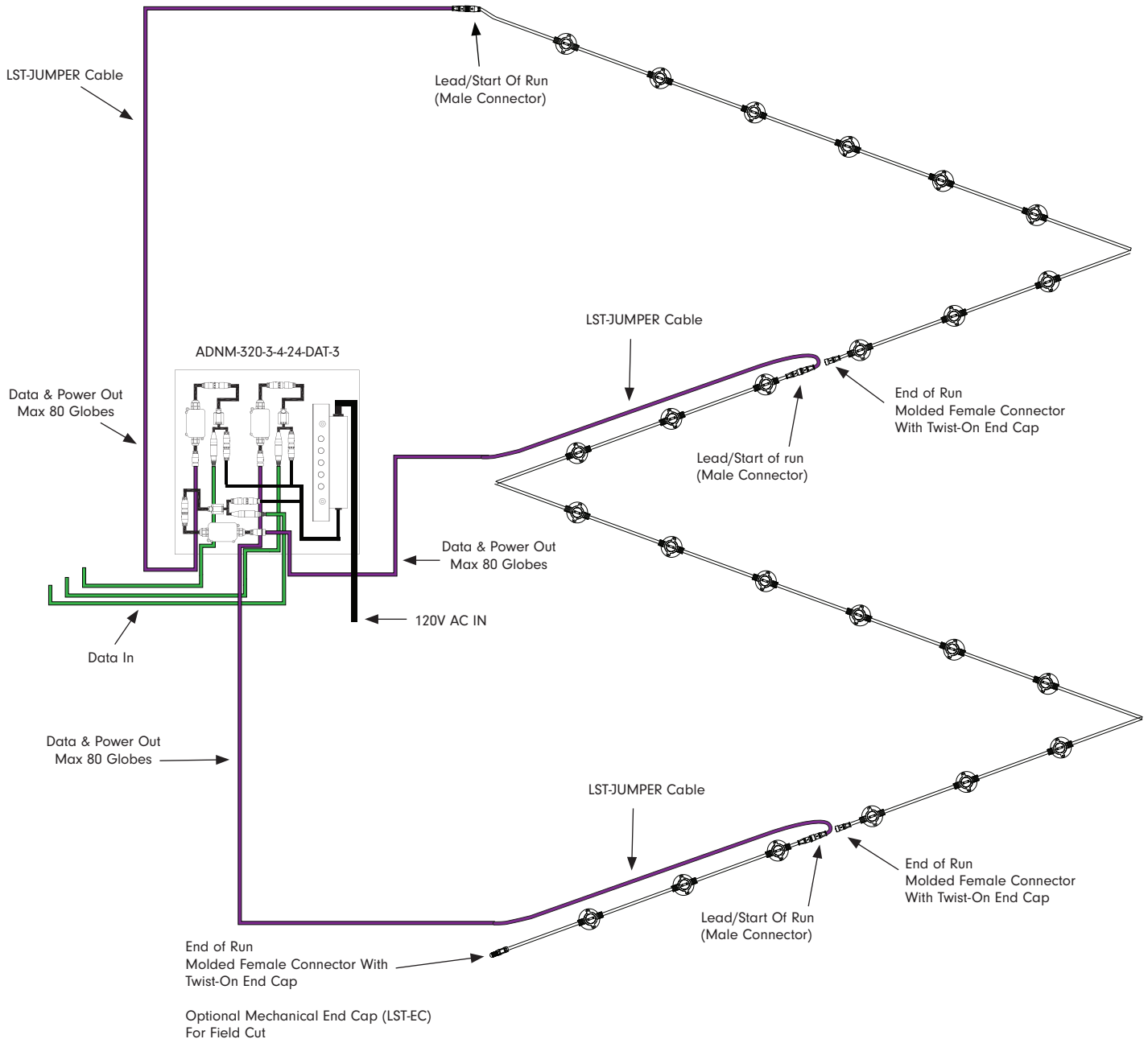

⚠ Warnings: Risk of injury or fire.

Do not cover any luminaire as the covering may cause it to overheat.

Do not install this lighting system where the exposed bare contacts can be shorted or contact any conductive material to reduce the risk of fire and burns.

Do not install any luminaire closer than 6 inches (15.25cm) from any curtain, or similar combustible material.

Do not use any luminaire if damaged; such as, broken globe, loose connections, or frayed wire insulation. Inspect periodically.

Do not submerge any luminaire in liquid. Use waterproof connectors for all outdoor applications.

Do not secure any luminaire with staples, nails or like means that might damage the wire insulation. Secure it by using screws through the base.

Do not run any luminaire at an operating temperature exceeding -20°C to 50°C (-4°F to 122°F)

Wiring Dual Runs with single circuit 96W

WARNING! Risk of Product Failure

The data & power out cable length from the ADNMM-DAT power supply to the first globe, must not exceed 80'
 The total data out length from the ADNMM-DAT power supply to the last globe, must not exceed 260'

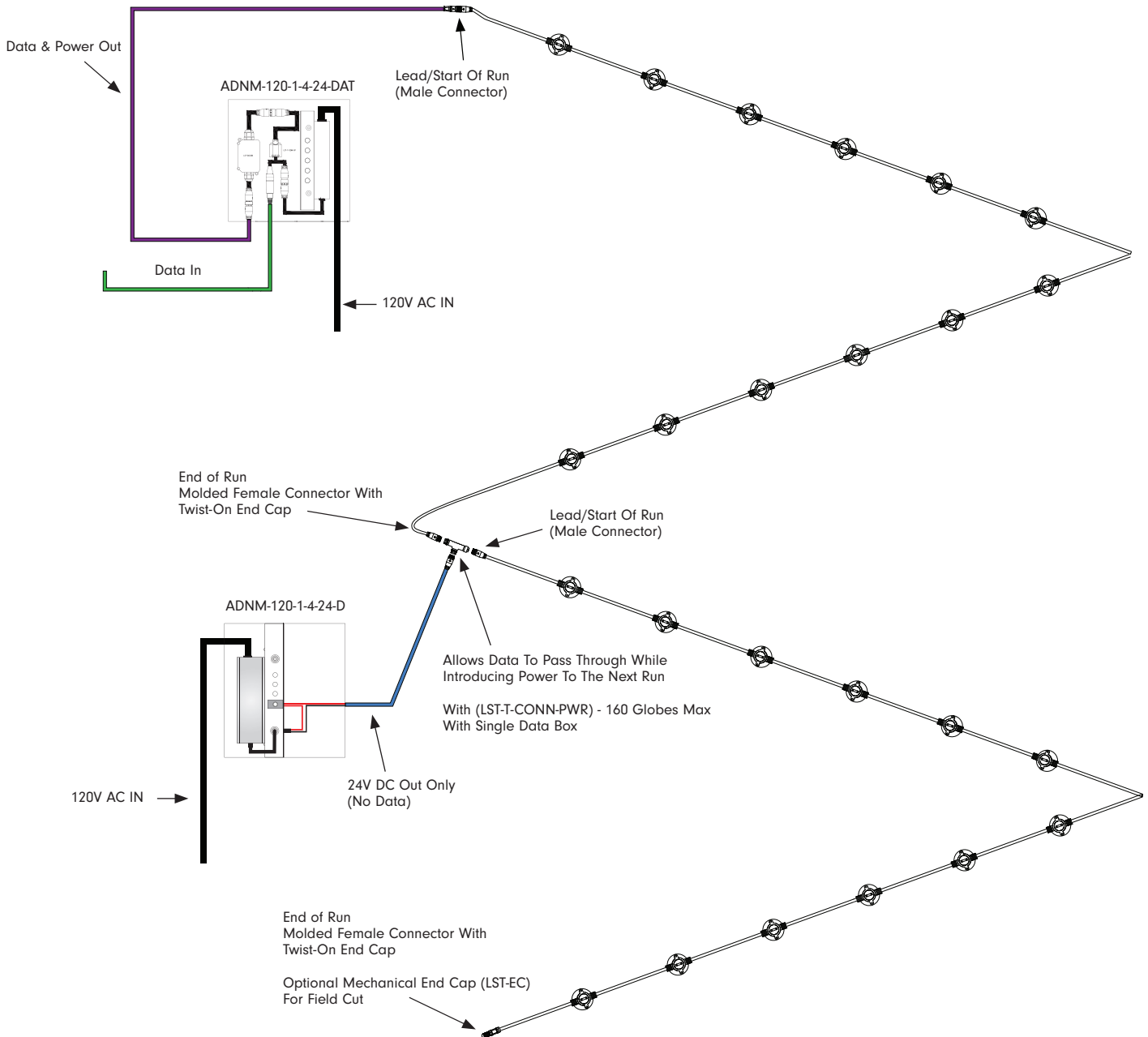

⚠ Warnings: Risk of injury or fire.

Do not cover any luminaire as the covering may cause it to overheat.

Do not install this lighting system where the exposed bare contacts can be shorted or contact any conductive material to reduce the risk of fire and burns.

Do not install any luminaire closer than 6 inches (15.25cm) from any curtain, or similar combustible material.

Do not use any luminaire if damaged; such as, broken globe, loose connections, or frayed wire insulation. Inspect periodically.

Do not submerge any luminaire in liquid. Use waterproof connectors for all outdoor applications.

Do not secure any luminaire with staples, nails or like means that might damage the wire insulation. Secure it by using screws through the base.

Do not run any luminaire at an operating temperature exceeding -20°C to 50°C (-4°F to 122°F)

Daisy-Chain Multiple Runs within single Universe

The below example setup is for **160 globes max on (1) universe** with different globe count per strand. This process includes **manually programming each Data Box for a specified DMX address** according to your setup. **Each Data Box must be addressed in house by the factory before shipment.**

WARNING! Risk of Product Failure

The data & power out cable length from the ADNM-DAT-D power supply to the first globe, must not exceed 80'

The total data out length from the ADNM-DAT-D power supply to the last globe, must not exceed 260'

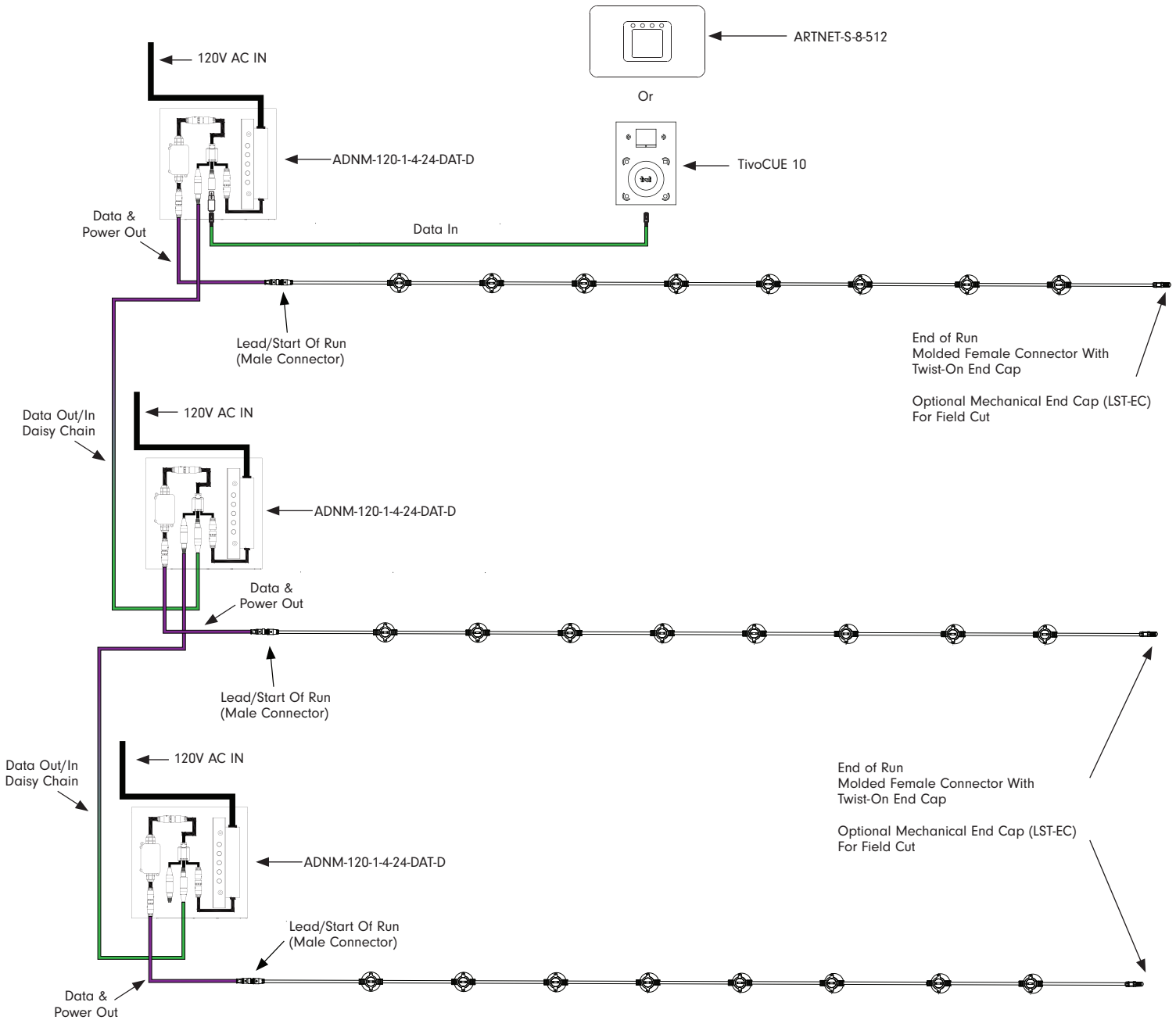

⚠ Warnings: Risk of injury or fire.

Do not cover any luminaire as the covering may cause it to overheat.

Do not install this lighting system where the exposed bare contacts can be shorted or contact any conductive material to reduce the risk of fire and burns.

Do not install any luminaire closer than 6 inches (15.25cm) from any curtain, or similar combustible material.

Do not use any luminaire if damaged; such as, broken globe, loose connections, or frayed wire insulation. Inspect periodically.

Do not submerge any luminaire in liquid. Use waterproof connectors for all outdoor applications.

Do not secure any luminaire with staples, nails or like means that might damage the wire insulation. Secure it by using screws through the base.

Do not run any luminaire at an operating temperature exceeding -20°C to 50°C (-4°F to 122°F)

Accessories



LST-JUMPER-X-XX
4 PIN jumper cable, IP67
X = B (Black), W* (White)
XX = 5, 10, 20 (lengths in ft)



JUMPER-XLR3P-X
Jumper Cable 3-PIN XLR
X = 5, 10, 25 (lengths in ft)



LST-EC-X
End Cap
X = B (Black), W* (White)



LST-T-CONN-PWR-X
T-CONN power pass through
X = B (Black), W* (White)



LST-PWR-2-X-XX
2 pin power lead (for T-CONN-PWR)
X = B (Black), W* (White)
XX = 10 (10'), 15 (15'), 20 (20'), 25 (25')



NTG-SWI-8PT
NETGEAR 8-Port Gigabit Ethernet Unmanaged Switch



NTG-SWI-16PT
NETGEAR 16-Port Gigabit Ethernet Unmanaged Switch



ARTNET-L-X-512
X = 8, 16 (ports)
8 or 16 port universe Artnet to DMX interface, 16 port 8192 DMX channels 8 port 4096 DMX channels (Online only)

*Consult factory for MOQ and lead-time

Controls & Software

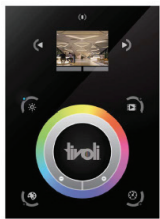

TVOQ-10-XX-7
XX = BK (Black), WH (White)
1024 DMX channel, 500 scene,
10 zone, glass touch screen

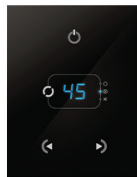

TVOQ-2-BK
512 DMX channel, 99 scene,
1 zone, glass touch screen



ARTNET-S-8-512
8 port universe Artnet to DMX interface, 4096 DMX channels (Online or Offline option)



Cue™ and CuePro™ softwares are specifically designed for the TivoCUE™ in-wall DMX controls and includes an array of tools required by the latest DMX lighting fixtures. Intuitive, with easy-to-use effects that can be dropped into timelines, and multi-zone synchronization capabilities allow you to program a project effortlessly.

MADRIX 5 Key & Software Levels

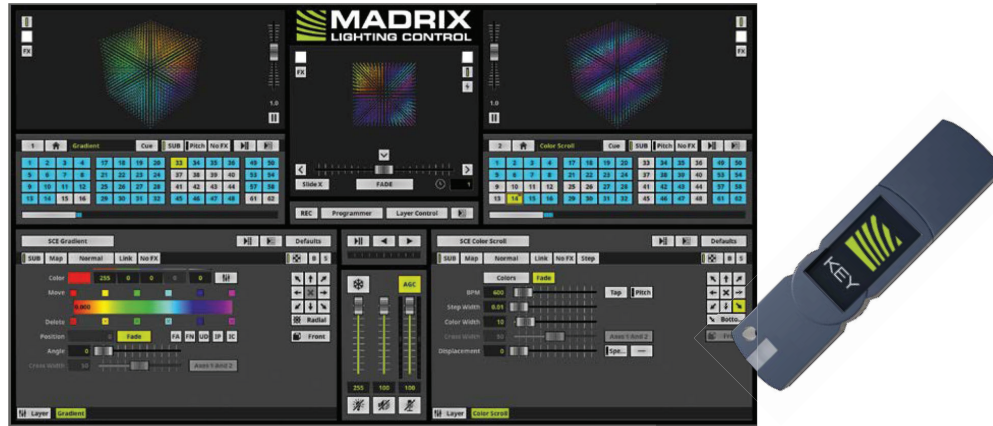

MADRIX KEY

A USB dongle unlocks the software’s full output. You can freely switch between different PCs as it is not bound to a specific one. It only needs to be activated on-line once.

MADRIX 5 LICENSE UPGRADES

You can easily upgrade your MADRIX 5 KEY to any higher license at any time, increasing the available output.

MADRIX 5 Key & Software Cat No	MDRX-LC-5S	MDRX-LC-5E	MDRX-LC-5B	MDRX-LC-5P	MDRX-LC-5U	MDRX-LC-5M
Level	START	ENTRY	BASIC	PROFESSIONAL	ULTIMATE	MAXIMUM
DMX-Based Output						
DMX Channels	1,024	4,096	16,384	65,536	262,144	1,048,576
DMX Universe Example	2	8	32	128	512	2,048
RGB Voxels Example	341	1,365	5,461	21,845	87,381	349,525
DVI-Based Output						
DVI Voxels	4,096	16,384	262,144	1,048,576	2,097,152	2,097,152
Render Resolution Example	64 X 64 PIXELS	128 X 128 PIXELS	512 X 512 PIXELS	1,024 X 1,024 PIXELS	2,048 X 1,024 PIXELS	2,048 X 1,024 PIXELS

Mounting Options

SURFACE/FLUSH

For surface mount applications, remove the top suspension-plate by turning counter-clockwise until off. Place socket flush against the desired surface and mount using proper screws according to substrate.



SUSPENDED

Suspended mounting will use a combination of LS-Cable, LS-Locks with LS-UVZP. Tension the cable wire with our LS-TT (Tension Tool) for desired sag (Please adhere to local city code for suspended application).

Note: For suspension application, a catenary cable is required for proper installation. Please contact Tivoli for recommendations on unique mounting applications.



Mounting Accessories



LS-CABLE-60 Catenary Cable Kit - 60'
(1/8" galvanized cable includes 2 cables locks for use with loads up to 200lbs)

LS-CABLE-110 Catenary Cable Kit - 110'
(1/8" galvanized cable includes 2 cables locks for use with loads up to 200lbs)

LS-CABLE-500 Catenary Cable Kit - 500'
(1/8" galvanized cable for use with loads up to 200lbs)



LS-UVZP-BK-XX UV Zip Ties

XX = 30 (30pc), 50 (50pc) Bag set. UV resistant, heavy duty ties. Maximum weight up to 100 lbs./per tie.



LS-LOCK-X Cable Lock

X = 2 (2 Locks), 4 (4 locks) Includes (1) cable release key. Cable Lock for 1/8th inch cable, Heavy-duty lockable fasteners support loads up to 200 lbs. Can be easily adjusted without the use of tools.



LS-TT

Catenary Cable Tensioning Tool up to 880lbs with minimal effort due to the 6:1 gear drive mechanism. Integral torque gauge controls the load applied to the wire, giving consistent tension every time and optimizing the life of the wire.

Light Shades Order Guide

HAT

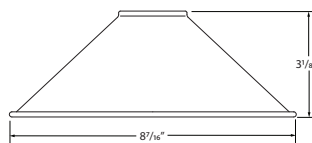

SHADE-HT-BK-BK-8
Light Shade - HAT
8.3" Black Top, Black Bottom
Weight: 0.38 lb

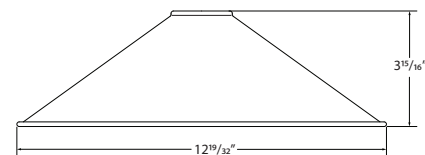

SHADE-HT-BK-BK-13*
Light Shade - HAT
12.6" Black Top, Black Bottom
Weight: 1.06 lb

SHADE-HT-BK-CO-13*
Light Shade - HAT
12.6" Black Top, Copper Bottom
Weight: 1.06 lb

*Consult factory for lead time and MOQ

DISH

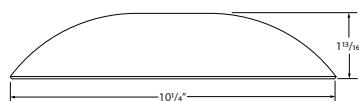

SHADE-DS-BK-BK-10
Light Shade - DISH
10.2" Black Top, Black Bottom
Weight: 0.72 lb

FLOWER

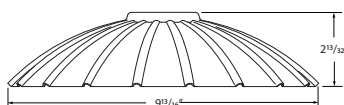
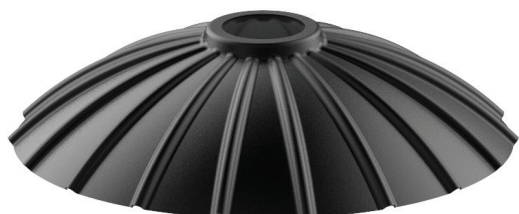

SHADE-FL-BK-BK-10
Light Shade - FLOWER
9.8" Light Shade, Black Top, Black Bottom
Weight: 0.54 lb

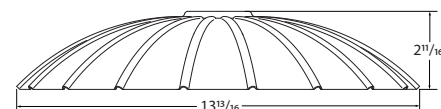

SHADE-FL-BK-BK-13
Light Shade - FLOWER
13.8" Light Shade, Black Top, Black Bottom
Weight: 1.1 lb

Replacement Globes 5"

PRODUCT CODE	PROFILE	SHADE
LSA2		
LSA2 = Litesphere ADAPT Globe	ANA = Ana ANG = Angela GIN = Gina GAB = Gabby KAT = Katie SUS = Susan* TON = Toni* LUC = Lucia* VIC = Victoria* LAU = Laura* BRE = Brenda*	Y = Yes N = No



LSA2-LUC-N
 Example part number shown is with **NO** shade option - Standard adapter applied at factory



LSA2-LUC-Y
 Example part number shown is with **YES** shade option - Shade adapter applied at factory

Replacement Parts



LST-RGBW-24
 Litesphere True RGB+W LED
 sold each



LST-DATABX
 Data Box
 (for custom programming consult factory)



LST-T-CONN-DSY
 Daisy-Chain T Connector, IP67
 3-PIN XLR Male
 3-PIN XLR Female
 5-PIN M16 Female for LED
 2-PIN M16 female (power)



DMX3-CAT5-ADPTR
 DMX Adapter
 3-pin XLR Female to RJ45



LST-T-CONN-3P
 T Connector, IP67
 3-PIN XLR Male for DMX
 5-PIN M16 Female for LED
 2-PIN M16 female to 2-PIN male

Power Supplies

DESCRIPTION	CAT NO	APPLICATION	PRIMARY VOLTAGE	SECONDARY VOLTAGE	CIRCUIT BREAKERS	MAX LOAD	CIRCUIT CAPACITY
ADNM Series Class 2 Transformer	ADNM-120-1-4-24-D	Indoor / Outdoor	100-277V AC 5% ₀₀ HZ	24V DC	1	96W	4A

ADNM-DAT / ALL - IN - ONE

Litesphere True RGB+W ADNM-DAT power supply is an all-in-one unit that comes with: Power Supply, LST Data Box, LST T-Conn, RJ45-to-XLR connection. All contained within our outdoor rated NEMA 3 box. Box size can vary depending on number of circuits.

DESCRIPTION	CAT NO	APPLICATION	PRIMARY VOLTAGE	SECONDARY VOLTAGE	CIRCUIT BREAKERS	DATA BOXES	MAX LOAD	CIRCUIT CAPACITY
ADNM Series Class 2 Transformer	ADNM-120-1-4-24-DAT	Indoor / Outdoor	100-277V AC 5% ₀₀ HZ	24V DC	1	1	96W	4A
	ADNM-240-2-4-24-DAT-2				2	2	2x96W	2x4A
	ADNM-320-3-4-24-DAT-3				3	3	3x96W	3x4A

ADNM-120-1-4-24-DAT
120-277V AC / 24V DC, 96W /1 CIRCUIT X 4A
1 LS RGB+W DATA BOX(s), (1) LST-T-CONN

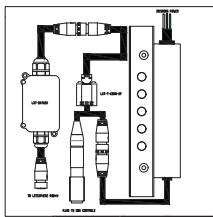

ADNM-240-2-4-24-DAT-2
120-277V AC / 24V DC, 192W /2 CIRCUITS X 4A
2 LS RGB+W DATA BOX(s), (1) LST-T-CONN

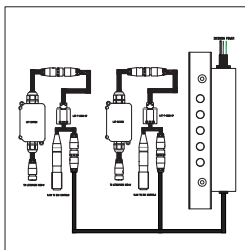

ADNM-320-3-4-24-DAT-3
120-277V AC / 24V DC, 288W /3 CIRCUITS X 4A
3 LS RGB+W DATA BOX(s), (1) LST-T-CONN

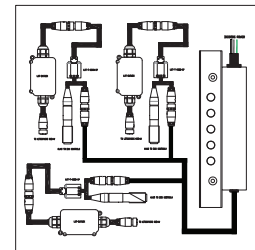

ADNM-DAT-D / ALL - IN - ONE

Litesphere True RGB+W ADNM-DAT-D power supply is an all-in-one unit that comes with: Power Supply, LST Data Box, LST T-Conn-DSY. All are contained within our outdoor rated NEMA 3 box that allows you to daisy-chain multiple runs (not to exceed 160 globes) to (1) DMX universe. Manual addressing of each Data Box must be done at the factory.

DESCRIPTION	CAT NO	APPLICATION	PRIMARY VOLTAGE	SECONDARY VOLTAGE	CIRCUIT BREAKERS	DATA BOXES	MAX LOAD	CIRCUIT CAPACITY
ADNM Series Class 2 Transformer	ADNM-120-1-4-24-DAT-D	Indoor / Outdoor	100-277V AC 5% ₀₀ HZ	24V DC	1	1	96W	4A

ADNM-120-1-4-24-DAT-D
120-277V AC / 24V DC, 96W /1 CIRCUIT X 4A
1 LS RGB+W DATA BOX(s), (1) LST-T-CONN-DSY

